

Product Overview

This Superior Panel is a multi-function device that combines with USB2.0 multi-slot memory card reader, 2-channel fan controller and multi I/O panel. Users can get 3 different functions with only one 5.25 " drive bay occupied. AS a memory card reader, it supports most popular memory cards. As a fan controller, it can adjust two fans speed. The multi I/O panel, it provides the most convenient front cable connection including USB2.0 / Audio ports / RCA connector / 1394 / eSATA. The Superior Panel is a perfect solution for the 5.25 " bay device.

Illustration of product

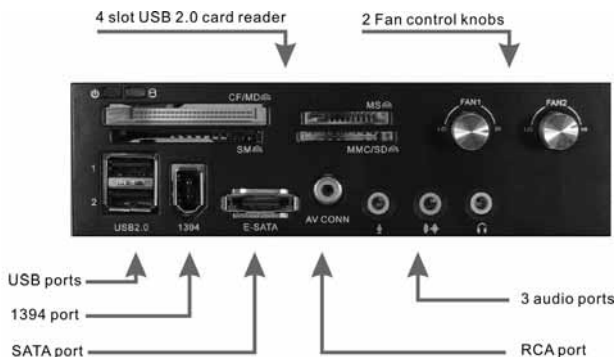

Package contents

The package should contain the following items:

1. The Multi-function Panel x 1
2. eSATA x 1
3. USB cable x 1 (2 ports)
4. 1394 cable x 1
5. RCA cable x 1
6. audio cable kit x 1 (3 ports)
7. Accessory kit x 1
8. This User's Guide

Specification:

DC Input	+5V / +12V , USB bus power
DC Output	4V – 12V DC
FAN CONTROL	2 SET (4V-12v)
3 pin fan connector	2
Memory card type	Compact Flash Type I/II Micro Drive Memory Stick Memory Stick Dual(card adapter) Memory Stick PRO Memory Stick Dual PRO(card adapter) Smart Media SD miniSD(card adapter) Multi Media Card RS-MMC (card adapter) T-flash (SD card adapter)
Interface of reader	USB 2.0
OS	Win 98se/me/2000/XP, Mac OS 8.6+

2.Feature

2.1 Multi-slot card reader module:

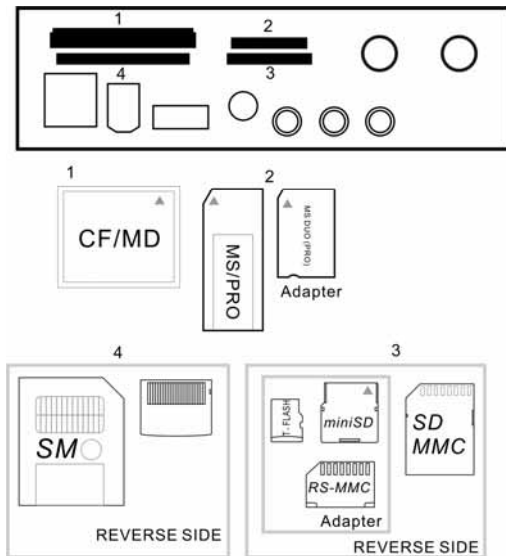

USB 2.0 High Speed Card Reader series provide you the easiest, fastest way to access your storage cards. By integrating the latest USB 2.0 technology, we will bring you the extremely fast speed up to 480Mbps/Sec. You can easily write/read files and images to the storage cards. This Reader accepts the following memory cards:

2.1.1. Features:

1. Hi-Speed USB 2.0 backwards compatible with all USB 1.1 ports
2. All 4 memory-slots are active, which allows you to copy data between the different memory cards at the same time.
3. USB Mass Storage Class Device.
4. Max Speed will be up to 480Mbit/sec
5. Plug & play and Hot Swapping
6. LED Indication for Power & Access
7. Windows 98/98SE/2000/XP and Mac OS 9.x/Mac OS

2.1.2. Card reader installation:

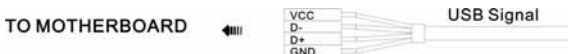

Pin of Reader	Pin of Motherboard	Description
VCC	VCC / +5V	USB +5V power
D-	D- / USB-	Negative Data
D+	D+ / USB+	Positive Data
GND	GND / Ground	Ground

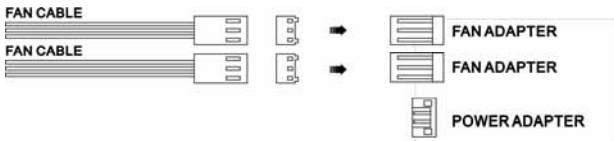

DC input:

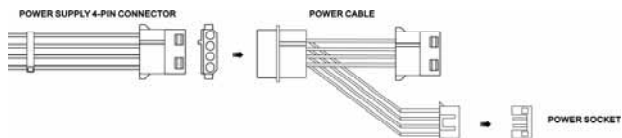

2.2 Setup for multi-I/O panel

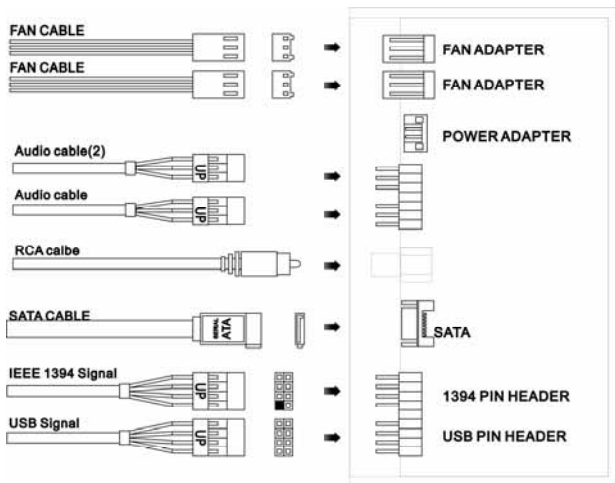

3.Installation:

1. Carefully insert the drive into 5.25" drive bay.
2. Fasten the drive into the carrier with screws.
3. Attach the 4-pin USB cable into motherboard's USB pin header.
4. Insert the 1394 cable into PC Bracket through the opening of L type bracket.
5. Insert the card reader USB cable into PC Bracket through the opening of L type bracket.
6. Attach the USB cable into MB pin header.
7. Attach the SATA cable into MB's SATA connectors.
8. Attach the USB/1394/audio/SATA cable into PCB pin header. (Make sure the position accurate by "UP" label)

4.Driver installation

4.1. Minimum System Requirements:

Windows

Pentium class PC with USB support
Windows 98SE, 2000, ME, XP
CD-ROM drive
USB 2.0 port required from Hi-Speed transfer.

Macintosh

Macintosh computer with USB support
Mac OS 9.1.x and 9.2.x, OS X v10.1.2+
CD-ROM drive
USB 2.0 port required from Hi-Speed transfer

4.2. Minimum System Requirements:

4.2.1. Installation for Windows 98/SE/2000

1. Insert the driver CD into the CD-ROM drive.
2. Click the CD-ROM drive icon.
3. Follow the step of "Install Wizard" to install the "USB Card Reader Driver".
4. Click "Yes" to reboot the system.
5. Plug your card reader into USB port and Windows 98SE will detect it automatically.
 - a. The pop-up window "Find new Hardware" will come out.
 - b. Wait for Windows 98SE to configure the card reader. When the installation (of the card reader driver) is successful, this pop-up window will disappear automatically.
 - c. Open "my computer", you'll see removable drives installed in your computer, then the installation is completed.
 - d. The installation is completed.

4.2.2 Installation for Windows ME/XP.

This card reader is a driver-free device for Windows ME/XP. You don't have to install any driver and can plug into USB port directly.

Windows ME/XP will detect and install all the associated files automatically.

4.3 Uninstall Driver:

1. Please run the setup process again to uninstall the

- driver.
2. Follow the on-screen instruction to complete the process.
 3. System would ask you to restart the computer, please choose “Yes, I want to restart my computer now” to restart your PC, the uninstall will be done.

4.4. Remove Device:

For Windows 98/98SE Users

- Before you remove your flash cards or reader, please wait for “Access LED” on reader stops blinking to prevent data loss.

For Windows ME/2000/XP Users

- Please double-click the icon  on the system tray. A dialog box will appear.

Double-click the Generic USB Storage Device to remove the device or cards for preventing from data loss.